

**Neurochirurgie und Laminektomie
Neurosurgery and Laminectomy
Neurochirurgie et Laminectomie
Neurocirugía y Laminectomía**

18

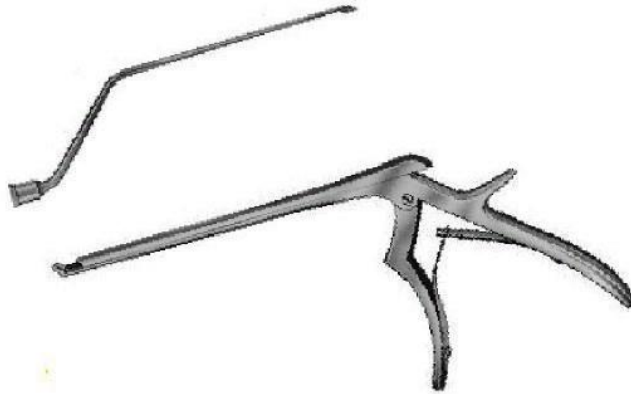

Instrumente zur schadelöffnung
 Instruments for cranial opening
 Instruments pour l'ouverture du crane
 Instrumentos para abertura craneana

Drahtsäge
 Wire Saw
 Scie en fil
 Sierra de hilo

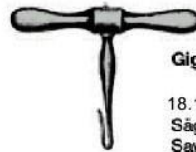

Gigli
 18.1323-00
 Sägegriff
 Saw handle
 Manche pour scies
 Mango para sierras



Olivecrona
 2-fach, two-fold, à deux pièces,
 de dos piezas
 1,2 mmØ

- | | | |
|------------|--------|-----------|
| 18.1320-30 | Fig. 1 | 30 cm/12" |
| 18.1320-40 | Fig. 2 | 40 cm/16" |
| 18.1320-50 | Fig. 3 | 50 cm/20" |
| 18.1320-60 | Fig. 4 | 60 cm/24" |
| 18.1320-70 | Fig. 5 | 70 cm/28" |

Gigli
 3-fach, three-fold, à trois pièces,
 de tres piezas
 1,4 mmØ

- | | | |
|------------|--------|-----------|
| 18.1321-30 | Fig. 1 | 30 cm/12" |
| 18.1321-40 | Fig. 2 | 40 cm/16" |
| 18.1321-50 | Fig. 3 | 50 cm/20" |
| 18.1322-50 | Fig. 1 | 50 cm/20" |

Martel
 Einführungsinstrument für Drahtsägen
 Conductor for wire saws
 Conducteur pour scies en fil
 Conductores para sierras de hilo

- | | |
|------------|--------------|
| 18.1324-30 | 30,0 cm/12" |
| 18.1324-33 | 33,0 cm/13¼" |

18



Dahlgren
 18.1328-20
 20,0 cm/8"

Schädelzangen
 Skull-Cutting Forceps
 Pinces pour le crâne
 Pinzas para el cráneo



De Vilbiss
 18.1329-21
 21,0 cm/8¼"

Schädelhalter
 Cervical traction tongs
 Pinces de traction crânienne
 Pinzas de tracción craneal

18



18.1340-00

Schädelhalter für die Extension des Halswirbels, Dorne verstellbar, Vorbohren nicht erforderlich

Cervical Traction Tong, for extension of the neck vertebrae, pins adjustable hence no initial drilling

Pinces de traction crânienne, pour l'extension des vertèbres cervicales, madirins réglables supprimant la perforation initiale

Pinza de tracción craneal para la extensión de las vértebras de cuello, puntas ajustables suprimiendo perforaciones iniciales

18.1340-01

Ersatzdorn, Spare pin only, Pointe de rechange seule, Punta de repuesto suelta



Crutchfield Fig. 1

18.1341-01

Schädelhalter

Cervical Traction Tong

Pinces de traction crânienne

Pinza de tracción craneal

Ø 3,5 mm



Ø 5,0 mm



18.1341-04
3,5 mm

18.1341-05
5,0 mm

Vorböhrer für Crutchfield Schädelhalter
 Drill Point for Crutchfield Cervical Traction Tongs
 Alésioir pour pinces de traction crânienne de Crutchfield
 Perforador inicial para pinzas de tracción craneal de Crutchfield



Crutchfield Fig. 2

18.1341-02

Schädelhalter

Cervical Traction Tong

Pinces de traction crânienne

Pinza de tracción craneal

Wirebelkorperspreizer Lamina spreaders

Wirebelkorperspreizer
Lamina spreaders
Ecarteurs pour corps vertebraux
Separadores para cuerpos vertebrales



Cloward
18.1345-16
16,0 cm/6½"

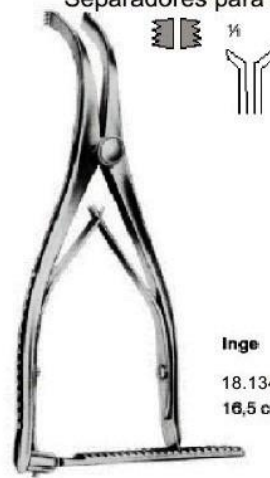

Inge
18.1345-17
16,5 cm/6½"

18

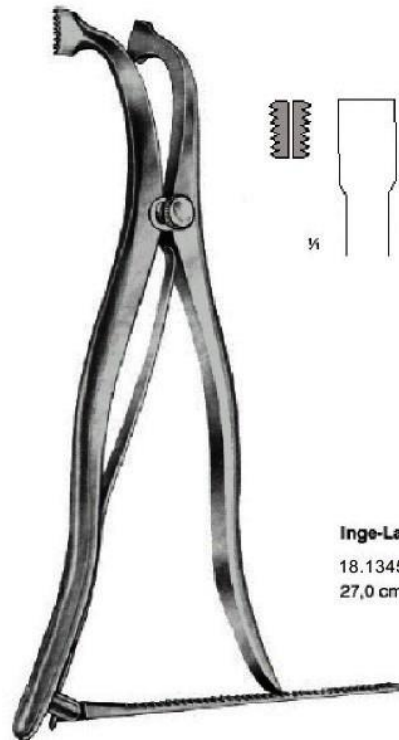

Inge-Lamina
18.1345-27
27,0 cm/10¾"

Klammern
Clips
Agrafes
Grapas

Klammer-anlege zangen
Clip applying forceps
Pincas pour appliquer des agrafes
Pinzas para poner grapas

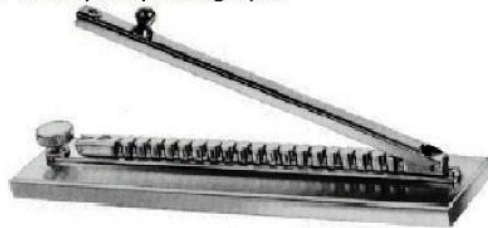

Mc Kenzie

18.1350-01

Klammernblock mit 1 Klammerbügel
Brain Clip Carrier, with 1 clip holding rack
Support porte-agraves, avec 1 rangée d'agrafes
Porta-grapas, con 1 riel para grapas
148 x 40 x 6 mm / 5¾ x 1½ x ¼"

18.1350-02

Klammernblock mit 2 Klammerbügel und
Schiebedeckeln
Brain Clip Carrier, with 2 clip holding rack and
sliding covers
Support porte-agraves, avec 2 rangée d'agrafes
et couvercle à glissière
Porta-grapas, con 2 rieles para grapas y tapas
corredizas
190 x 48 x 13 mm / 7½ x 2 x ½"

18



18.1351-00

100 Stück Silberklammern in Plastikbehälter
100 pieces Silver Brain Clips in plastic case
100 pièces agrafes en argent, dans une boîte
de plastique
100 piezas grapas de plata en tubo de
plástico

¼



McKenzie

18.1352-00

Silberdraht in Ringen zu 2,5 Gramm
Silver Wire in coils of 2,5 g
Fil d'argent, par rouleaux de 2,5 g
Hilo de plata en rollos de 2,5 g

½



Raney

18.1354-00

16,0 cm/6½"
Anlege- und Abnehmezange für Kopfhaut-klammern
Applying and Removing Forceps for Scalp Hemostasis
Clips
Pince pour appliquer et enlever les clips hémostatiques
pour le cuir chevelu
Pinza para aplicar y quitar clips hemostáticas para el
cuero cabelludo

½



Raney

18.1353-00

Kopfhautklammer
Scalp Hemostasis Clip
Clip hémostatique pour
le cuir chevelu
Clip hemostática para
el cuero cabelludo

¼

Pinzas para poner grapas

Klammer-anlege zangen
Clip applying forceps
Pinces pour appliquer des agrafes
Pinzas para poner grapas

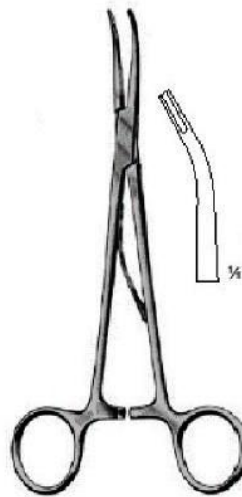

Klammer-Anlegezangen,
gebogen
Clip Applying Forceps,
curved
Pinces pour appliquer des
agrafes, courbes
Pinzas para poner grapas,
curvas

McKenzie

18.1360-15 15,0 cm/6"
18.1360-19 19,0 cm/7½"

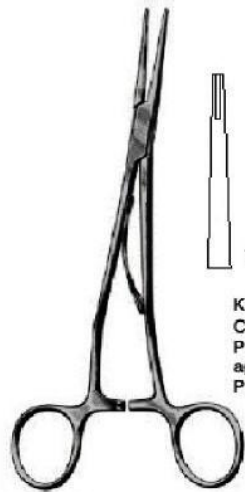

Klammer-Anlegezangen, gerade
Clip Applying Forceps, straight
Pinces pour appliquer des
agrafes, droits
Pinzas para poner grapas, rectas

McKenzie

18.1361-15 15,0 cm/6"
18.1361-19 19,0 cm/7½"

18

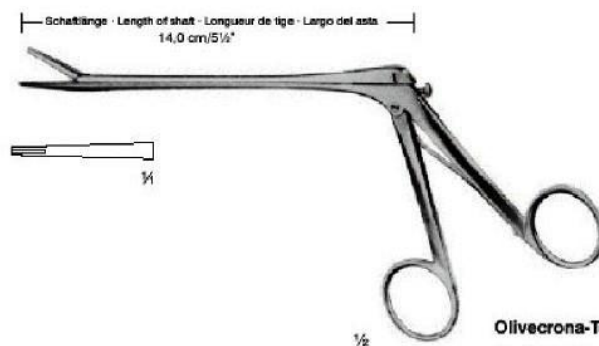

Olivecrona-Toennis

18.1362-14
14,0 cm/5½"

Klammer-Anlegezange
Clip Applying Forceps
Pince pour appliquer des agrafes
Pinza para poner grapa

Himspatel
Brain spatulas
Spatules cerebrales
Espatulas cerebrales

18



Cushing
18,0 cm/7"

	mm
18.1364-01	7/ 9
18.1364-02	11/13
18.1364-03	15/18
18.1364-04	18/22



100 mm

Heifetz
biegsam, malleable
malléable, malleable
20,0 cm/8"

	mm
18.1365-08	8
18.1365-11	11
18.1365-14	14
18.1365-17	17
18.1365-20	20



Olivecrona
18,0 cm/7"

Spatelbreite, mm
Width of spatulas, mm
Largeur de spatule, mm
Anchura de espátulas, mm

	oben upper end en haut arriba	unten lower end en bas abajo	
18.1366-01	7	9	18.1367-01
18.1366-02	11	13	18.1367-02
18.1366-03	15	18	18.1367-03
18.1366-04	18	22	18.1367-04

Ganchos para exploración y coagulación

Explorations-und koagulationshokchen
Exploration and coagulation hooks
Crochets d'exploration y coagulation
Ganchos para exploracion y coagulation



Fig. 1

18.1369-01

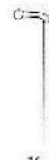

Fig. 2

18.1369-02



Fig. 3

18.1369-03



Fig. 4

18.1369-04

18

Caspar
24,5 cm/9¾"

geknöpft, isoliert
probe-end, insulated
boutonné, isolé
abotonado, aislado

Fadenführer Nerv-und gefaßhaken
 Ligature guides Nerve-and vessel hooks
 Passe-fils Crochets a nerf et a vaisseaux
 Guia-ligaduras Ganchos para nervios y vasos

18

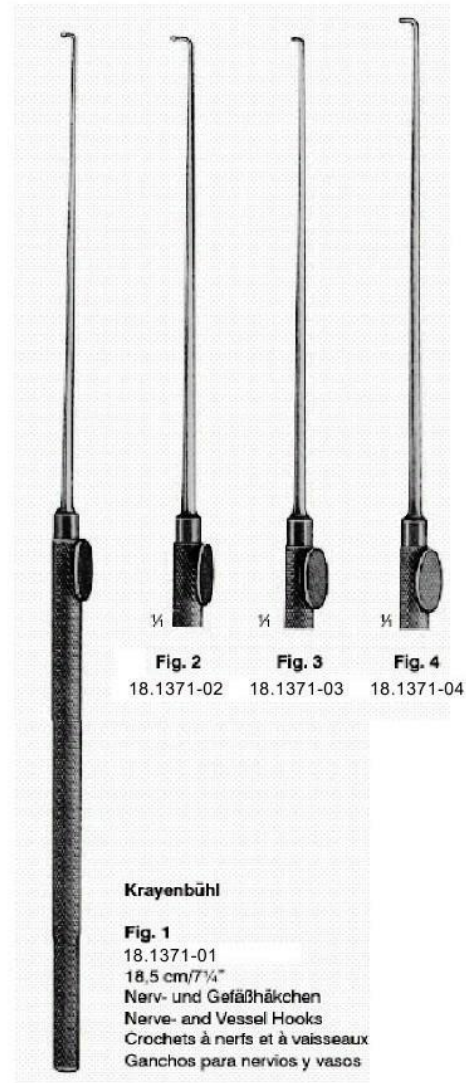
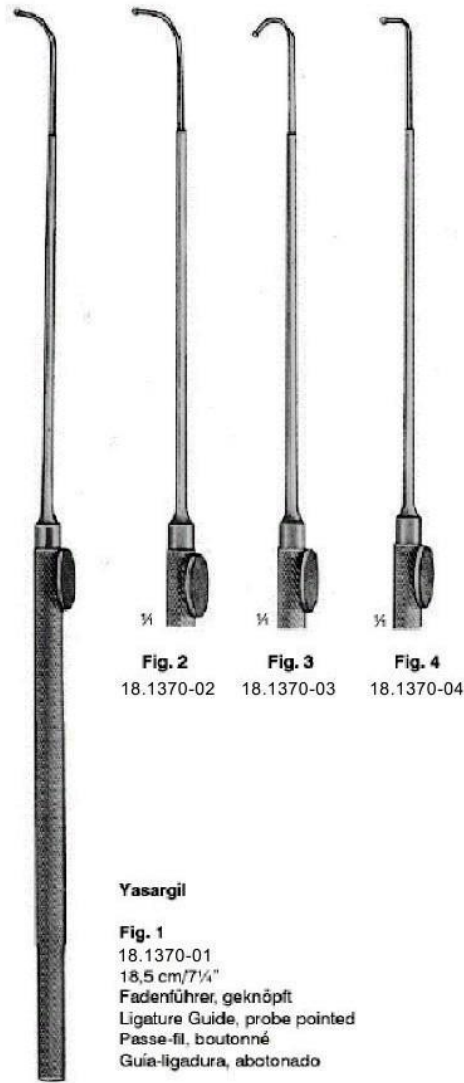

Mikro-Häkchen
Micro Hooks

Mikro-raspatorien
Micro raspatories
Micro-crochets
Micro-rugines
Micro-ganchitos
Micro-periostotomos

90°

90°

1 mm

18



Fig. 1
18.1374-01

Fig. 2
18.1374-02

Fig. 3
18.1374-03



Fig. 4
18.1374-04

Fig. 5
18.1374-05

Fig. 6
18.1374-05

Fisch

Yasargil

18.1372-19
18,5 cm/7 1/4"

Durahäkchen
Dura Hook
Crochet pour la dure-mère
Ganchito para dura-madre

18.1373-19
18,5 cm/7 1/4"

Feines Häkchen
Delicate Hook
Crochet fin
Ganchito muy fino

18.1374-00

Mikro-Raspator
Micro-raspatory
Micro-rugine
Micro-periostótomo

Mikro-loffel	Mikro-gabein	Mikro-raspatorien
Micro scoops	Micro forks	Micro raspatories
Micro-curettes	Micro-fourches	Micro-rugines
Micro-cucharillas	Micro-empujadores	Micro-periostotomos

18



Yasargil
18,5 cm/7¼"
Fadengabel
Suture pusher
Fourche à fil
Empujador de sutura

Fig. 1
18.1375-01

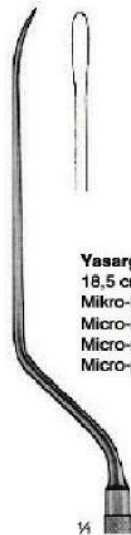

Yasargil
18,5 cm/7¼"
Mikro-Raspatorien
Micro-raspatories
Micro-rugines
Micro-periostótomos

Fig. 2
18.1375-02



Fig. 3
18.1375-03



Fig. 4
18.1375-04



Yasargil
18,5 cm/7¼"
Scharfer Löffel
Scoop, bayonet-shaped
Curette tranchante
Cucharilla cortante

18.1376-19



Jakobson
18,5 cm/7¼"
Doppelsonde
Twin Probe
Sonde double
Sonda doble

18.1377-19



Jacobson
18,5 cm/7¼"
Knopfsonde
Buttoned Probe
Sonde boutonée
Sonda abotonada

18.1378-19

Mikro-Cuchillos para vasos

Mikro-gafaBmesser
 Micro vessel knives
 Micro-couteaux a vaisseaux
 Micro-cuchillos para vasos

18

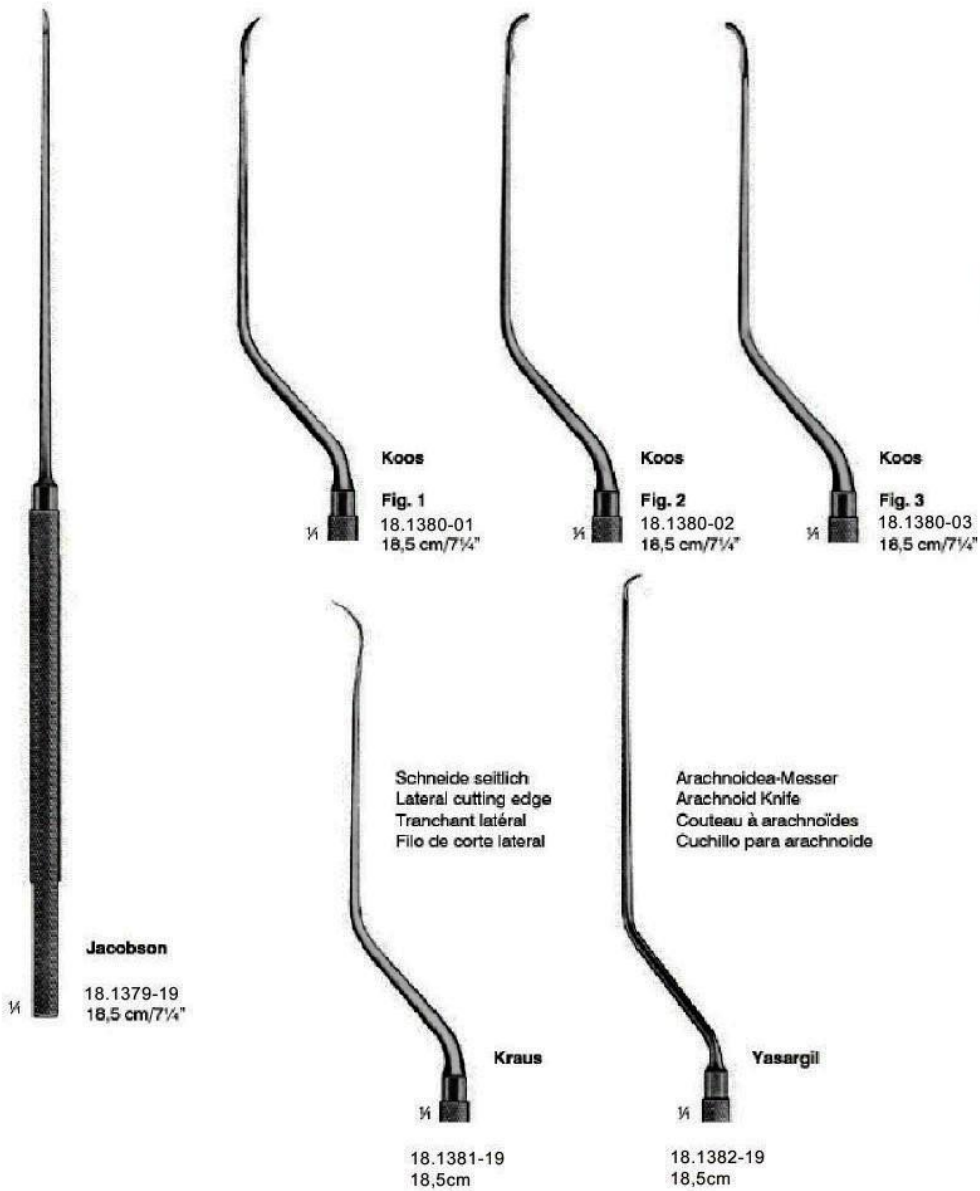

Galeahaken
Galea hooks
Crochets de galeati
Gancho para galea

18

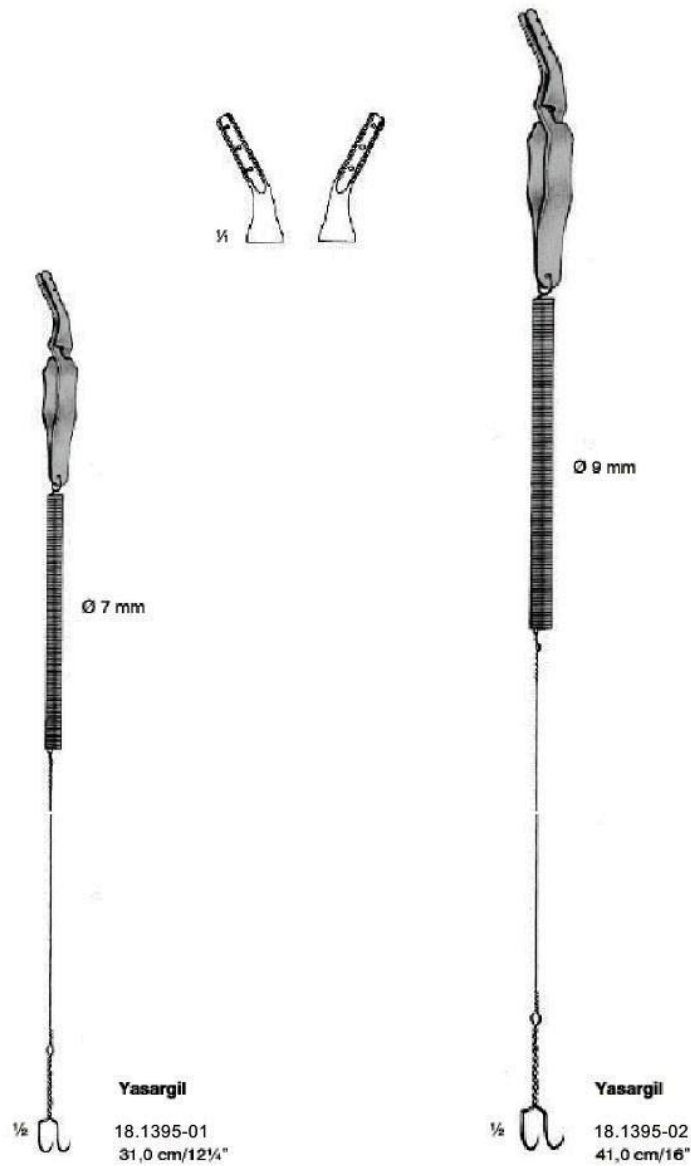

Surgeons Instruments in Surgical Suite
 Dissectores para dura-medra

Dura-dissektoren
 Dura dissectors
 Dissecteurs a dure-mere
 Disecadores para dura-medre

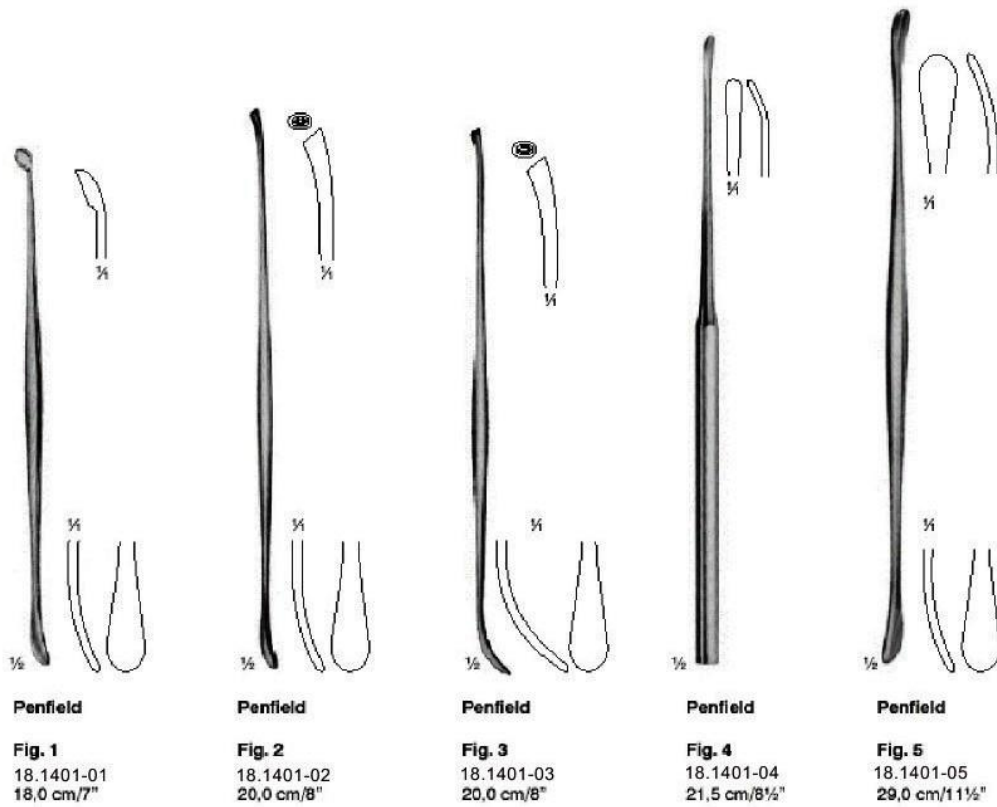

18

Dura-dissektoren
 Dura dissectors
 Dissecteurs a dure-mere
 Disecadores para dura-medre

18

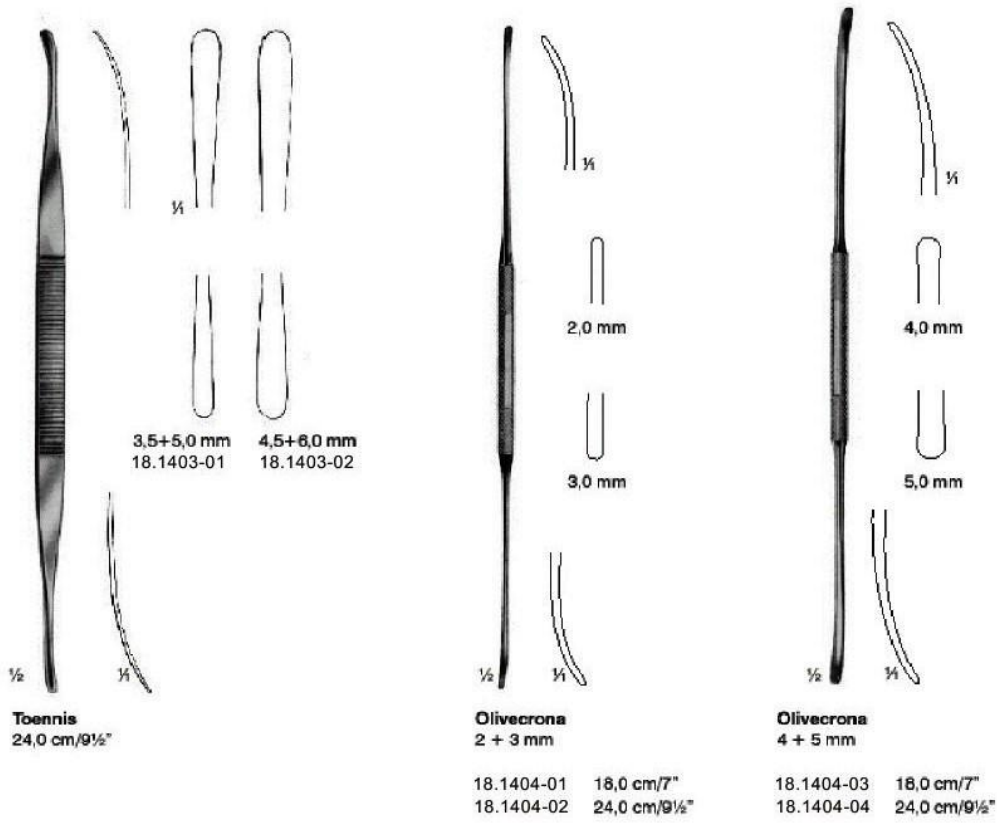

Dissectores para dura-madre

Dura-dissektoren
Dura dissectors
Dissecteurs a dure-mere
Disecadores para dura-medre

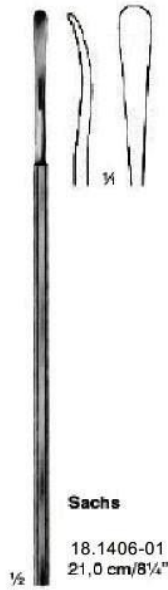

Sachs

18.1406-01
21,0 cm/8¼"



Sachs

18.1406-02
21,0 cm/8¼"

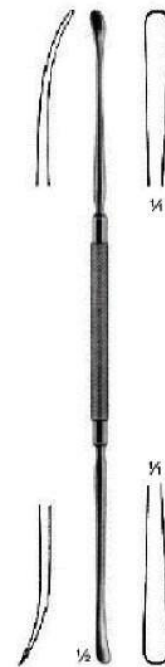

Davis
4 mm

18.1407-24
24,5 cm/9¾"

18



Frazier

18.1410-01
15,0 cm/6"



Hoen

18.1410-02
15,0 cm/6"



Hoen

18.1410-03
15,0 cm/6"

Dura-Separatoren
Dura Dissectors
Dissecteurs pour la dure-mère
Descoladores de dura-madre

Nervwurzelnhaken
 Nerve root retractors
 Retracteurs pour racines nerveuses
 Separadores de raiz de nervios

18

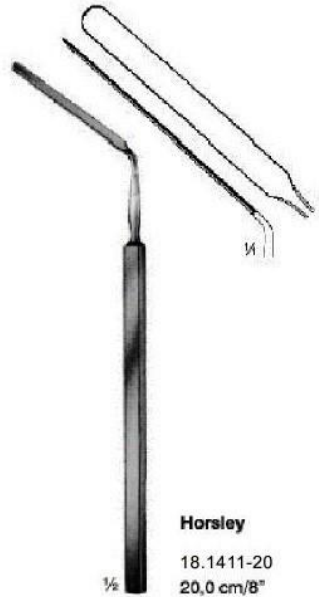

Dura Separator
 Dura Dissector
 Dissecteur pour la dure-mère
 Descolador de dura-madre

Horsley
 18.1411-20
 20,0 cm/8"

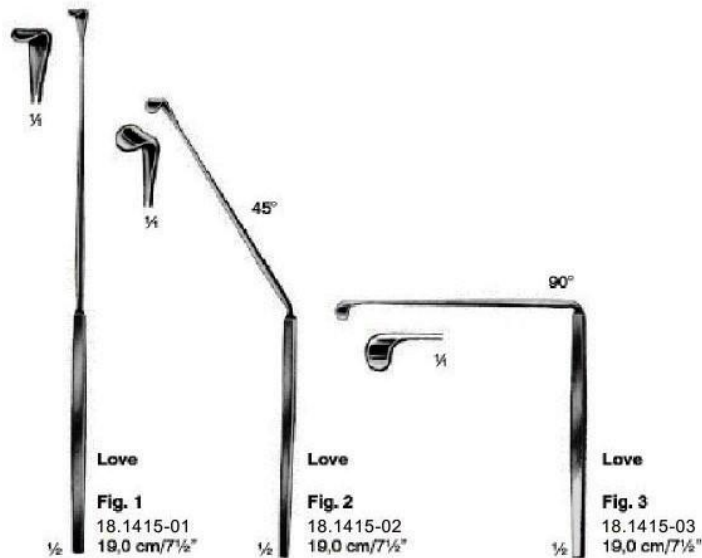

Love
Fig. 1
 18.1415-01
 19,0 cm/7½"

Love
Fig. 2
 18.1415-02
 19,0 cm/7½"

Love
Fig. 3
 18.1415-03
 19,0 cm/7½"

Dispositivos para separar los nervios

Nervwurzelhaken
Nerve root retractors
Retracteurs pour racines nerveuses
Separadores de raiz de nervios

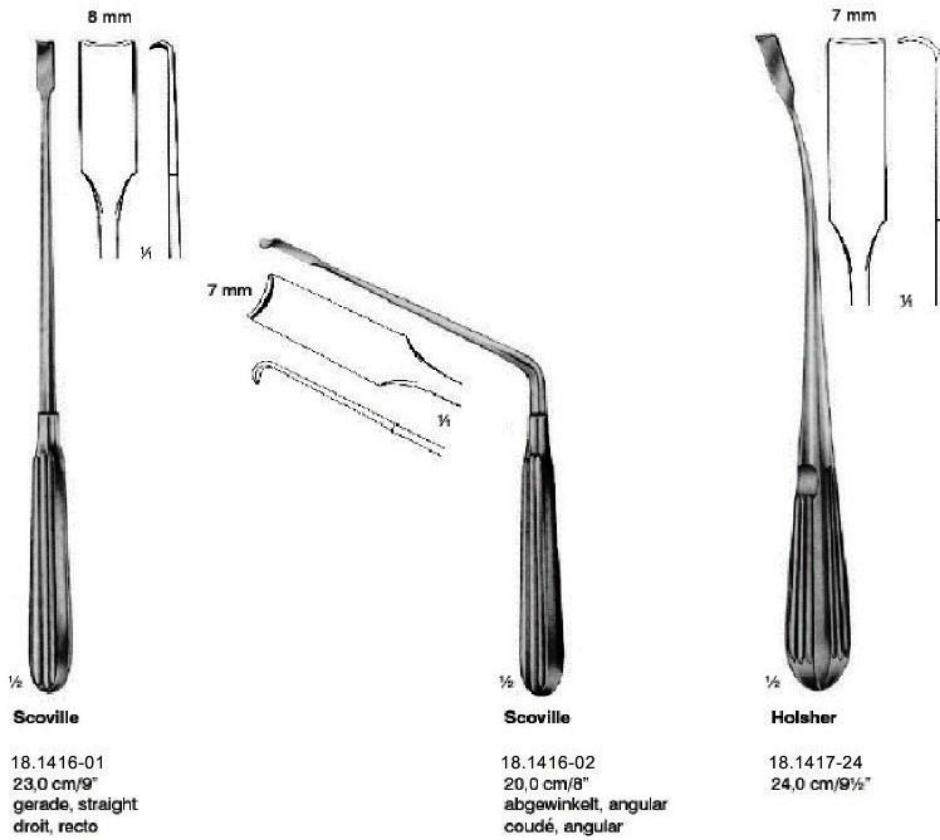

18

Nerv haken
Nerve hooks
Crochets a nerfs
Ganchos para nervios

18

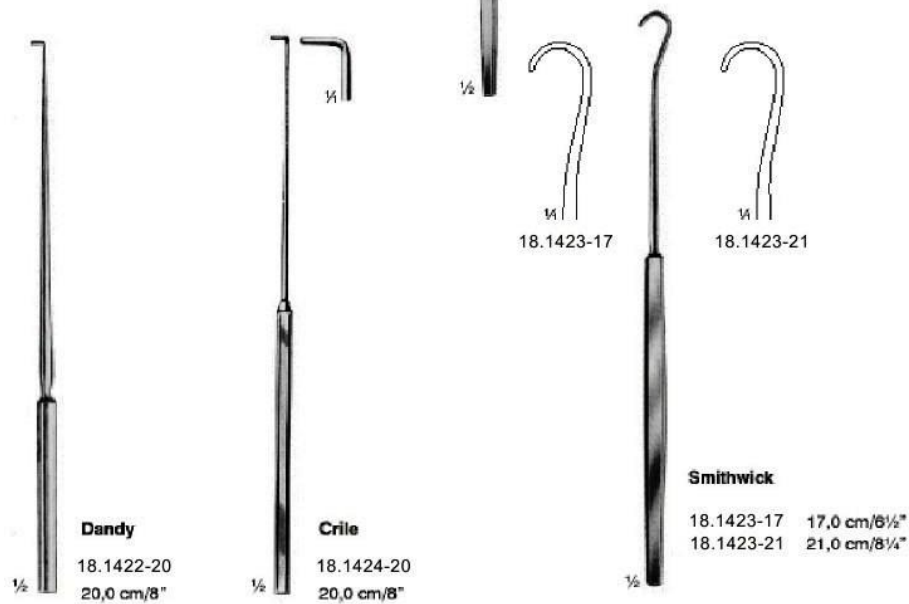
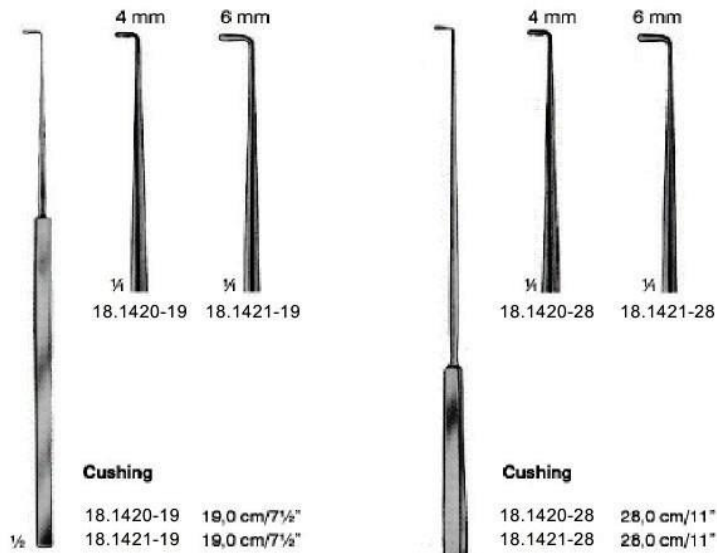

Bandscheiben-rongeure
 Intervertebral disc rongeurs
 Pincas a discos vertebrales
 Pinzas para discos vertebrales

18

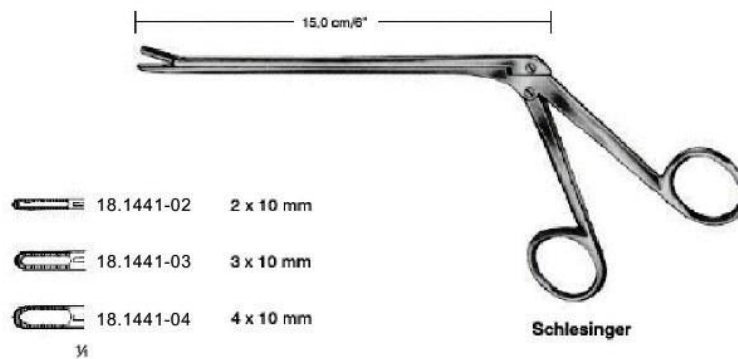
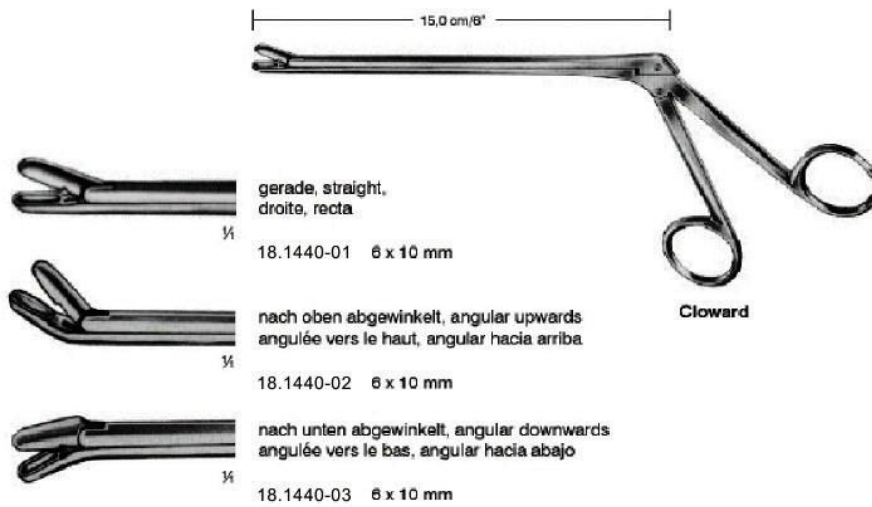

Pinces emporte-leses a laminectomia
 Pinzas cortantes para laminectomia

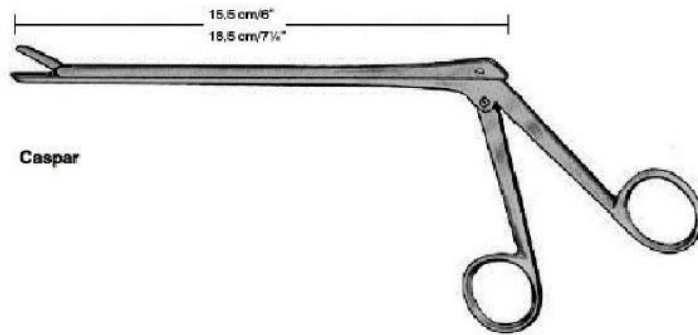

Laminektomie-zangen
 Laminectomy rongeurs
 Pinces emporte-leces a laminectomie
 Pinzas cortantes para laminectomia





Caspar

18





	 2 x 12 mm	 3 x 12 mm	 4 x 14 mm
15,5 cm/6"	18.1442-02	18.1442-03	18.1442-04
18,5 cm/7 1/4"	18.1443-02	18.1443-03	18.1443-04



	 2 x 12 mm	 3 x 12 mm	 4 x 14 mm
15,5 cm/6"	18.1444-02	18.1444-03	18.1444-04
18,5 cm/7 1/4"	18.1445-02	18.1445-03	18.1445-04



	 2 x 12 mm	 3 x 12 mm	 4 x 14 mm
15,5 cm/6"	18.1446-02	18.1446-03	18.1446-04
18,5 cm/7 1/4"	18.1447-02	18.1447-03	18.1447-04

Laminektomie-zangen
 Laminectomy rongeurs
 Pincas emporte-leces a laminectomia
 Pinzas cortantes para laminectomia

18

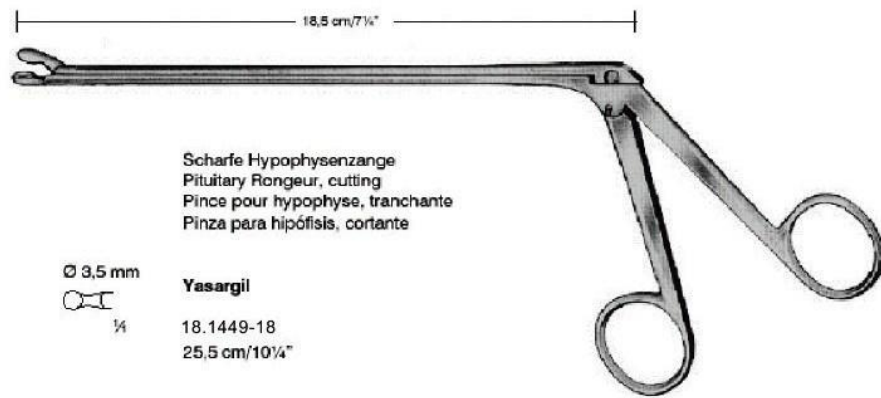
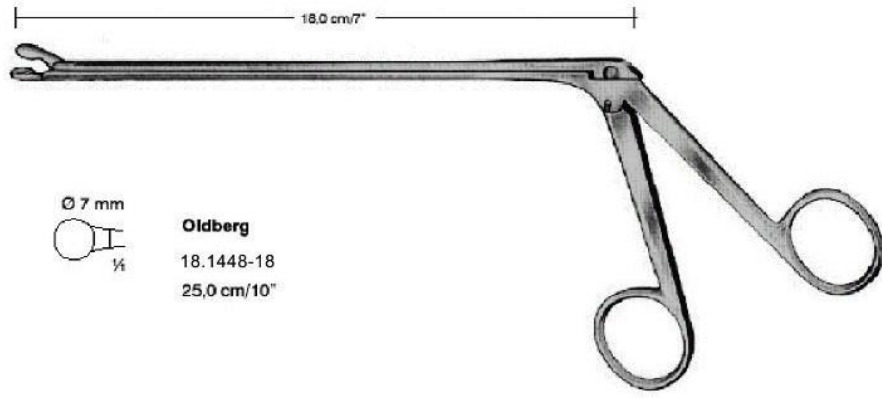
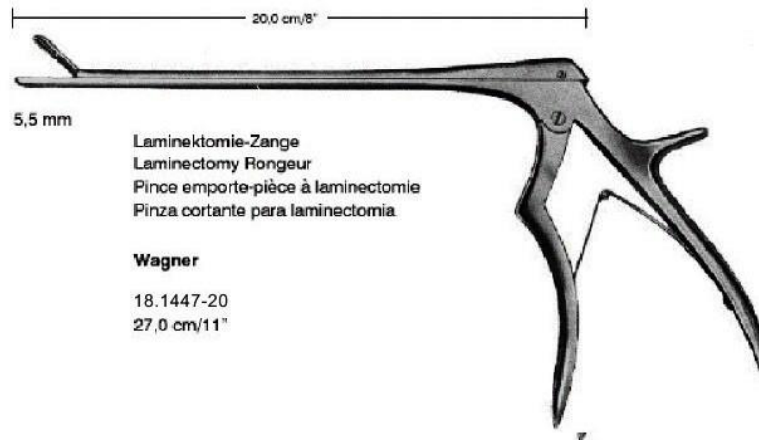

INSTRUMENTOS DE MANEJO DE DISCOS INTERVERTEBRALES
 Instrumentos para cirugía de discos intervertebrales

Bandscheiben-rongeure
 Intervertebral disc rongeurs
 Pinces a discos vertebrales
 Pinzas para discos vertebrales

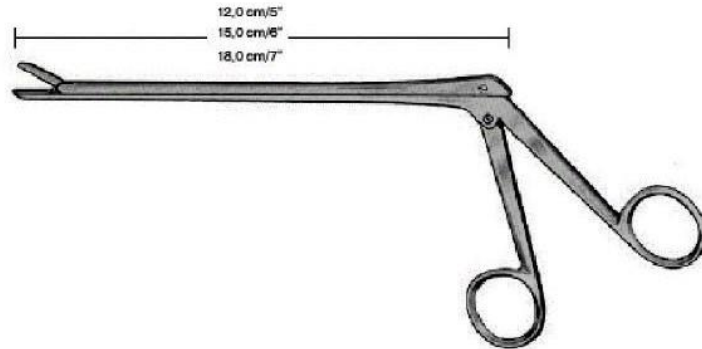

18

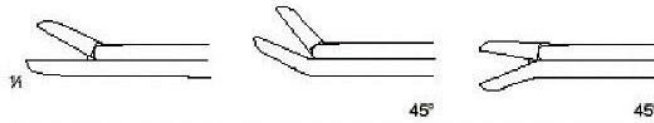

Cushing
2 x 10mm

12,0 cm/5"	18.1450-12	18.1451-12	18.1452-12
15,0 cm/6"	18.1450-15	18.1451-15	18.1452-15
18,0 cm/7"	18.1450-18	18.1451-18	18.1452-18

Love-Gruenwald
3 x 10mm

12,0 cm/5"	18.1460-12	18.1461-12	18.1462-12
15,0 cm/6"	18.1460-15	18.1461-15	18.1462-15
18,0 cm/7"	18.1460-18	18.1461-18	18.1462-18

Spurling
4 x 10mm

12,0 cm/5"	18.1470-12	18.1471-12	18.1472-12
15,0 cm/6"	18.1470-15	18.1471-15	18.1472-15
18,0 cm/7"	18.1470-18	18.1471-18	18.1472-18

Bandscheiben-rongeure
 Intervertebral disc rongeurs
 Pincas a discos vertebrales
 Pinzas para discos vertebrales



18

	90° nach oben schneidend 90° upwards cutting coupante vers le haut 90° cortante hacia arriba 90°	Bißbreite Width of bite Grandeur de coupe Ancho de la boca	reguläres Modell regular pattern modèle regulier modelo regular		zerlegbares Modell dismantable pattern modèle démontable modelo desmontable	
			Schaftlänge , Length of shaft Longueur de tige, Largo del asta	Schaftlänge , Length of shaft Longueur de tige, Largo del asta	Schaftlänge , Length of shaft Longueur de tige, Largo del asta	Schaftlänge , Length of shaft Longueur de tige, Largo del asta
¼		1 mm	18.1480-01	18.1481-01	18.1486-01	18.1487-01
□		2 mm	18.1480-02	18.1481-02	18.1486-02	18.1487-02
□		3 mm	18.1480-03	18.1481-03	18.1486-03	18.1487-03
□		4 mm	18.1480-04	18.1481-04	18.1486-04	18.1487-04
□		5 mm	18.1480-05	18.1481-05	18.1486-05	18.1487-05
□		6 mm	18.1480-06	18.1481-06	18.1486-06	18.1487-06

	40° nach oben schneidend 40° upwards cutting coupante vers le haut 40° cortante hacia arriba 40°	Bißbreite Width of bite Grandeur de coupe Ancho de la boca	reguläres Modell regular pattern modèle regulier modelo regular		zerlegbares Modell dismantable pattern modèle démontable modelo desmontable	
			Schaftlänge , Length of shaft Longueur de tige, Largo del asta	Schaftlänge , Length of shaft Longueur de tige, Largo del asta	Schaftlänge , Length of shaft Longueur de tige, Largo del asta	Schaftlänge , Length of shaft Longueur de tige, Largo del asta
¼		1 mm	18.1482-01	18.1483-01	18.1488-01	18.1489-01
□		2 mm	18.1482-02	18.1483-02	18.1488-02	18.1489-02
□		3 mm	18.1482-03	18.1483-03	18.1488-03	18.1489-03
□		4 mm	18.1482-04	18.1483-04	18.1488-04	18.1489-04
□		5 mm	18.1482-05	18.1483-05	18.1488-05	18.1489-05
□		6 mm	18.1482-06	18.1483-06	18.1488-06	18.1489-06

Pinzas para discos vertebrales

Bandscheiben-rongeure
Intervertebral disc rongeurs
Pinces a disques vertebrales
Pinzas para discos vertebrales

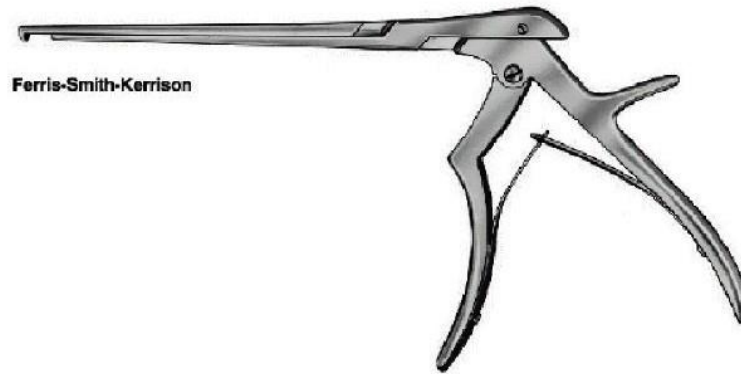

18



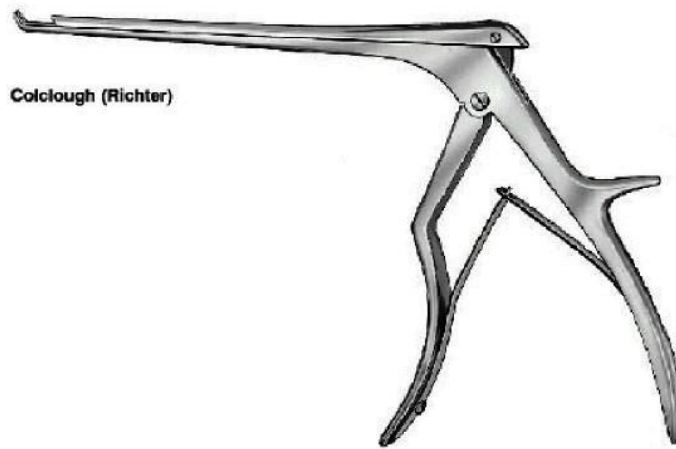

	90° nach unten schneidend 90° downwards cutting coupante vers le bas 90° cortante hacia abajo 90°	Bißbreite Width of bite Grandeur de coupe Ancho de la boca	Schaftlänge , Length of shaft Longueur de tige, Largo del asta	
			18,0 cm/7"	20,0 cm/8"
□		1 mm	18.1484-01	18.1485-01
□		2 mm	18.1484-02	18.1485-02
□		3 mm	18.1484-03	18.1485-03
□		4 mm	18.1484-04	18.1485-04
□		5 mm	18.1484-05	18.1485-05
□		6 mm	18.1484-06	18.1485-06

Bandscheiben-rongeure
 Intervertebral disc rongeurs
 Pincas a discos vertebrales
 Pinzas para discos vertebrales

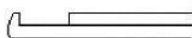

Colclough (Richter)

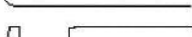
18

	90° nach oben schneidend 90° upwards cutting coupante ver le haut 90° cortante hacia arriba 90°	Bißbreite Width of bite Grandeur de coupe Ancho de la boca	Schaftlänge , Length of shaft Longueur de tige, Largo del asta		
			15,0 cm/6"	18,0 cm/7"	20,0 cm/8"
¼ □		2 mm	18.1502-15	18.1502-18	18.1502-20
□		3 mm	18.1503-15	18.1503-18	18.1503-20
□		4 mm	18.1504-15	18.1504-18	18.1504-20
□		5 mm	18.1505-15	18.1505-18	18.1505-20
□		6 mm	18.1506-15	18.1506-18	18.1505-20

Bandscheiben-rongeure
Intervertebral disc rongeurs
Pincas a discos vertebrales
Pinzas para discos vertebrales

Colclough (Richter)

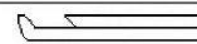
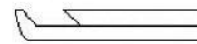
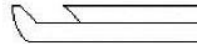
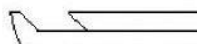
	40° nach oben schneidend 40° upwards cutting coupante vers le haut 40° cortante hacia arriba 40°	Bibbreite Width of bite Grandeur de coupe Ancho de la boca	Schaftlänge , Length of shaft Longueur de tige, Largo del asta		
			15,0 cm/6"	18,0 cm/7"	20,0 cm/8"
¼ □		2 mm	18.1512-15	18.1512-18	18.1512-20
□		3 mm	18.1513-15	18.1513-18	18.1513-20
□		4 mm	18.1514-15	18.1514-18	18.1514-20
□		5 mm	18.1515-15	18.1515-18	18.1515-20
□		6 mm	18.1516-15	18.1516-18	18.1515-20

18

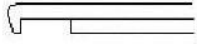
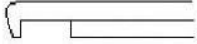
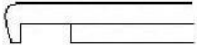
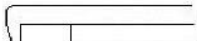
	90° nach unten schneidend 90° downwards cutting coupante vers le bas 90° cortante hacia abajo 90°	Bibbreite Width of bite Grandeur de coupe Ancho de la boca	Schaftlänge , Length of shaft Longueur de tige, Largo del asta		
			15,0 cm/6"	18,0 cm/7"	20,0 cm 8"
¼ □		2 mm	18.1522-15	18.1522-18	18.1522-20
□		3 mm	18.1523-15	18.1523-18	18.1523-20
□		4 mm	18.1524-15	18.1524-18	18.1524-20
□		5 mm	18.1525-15	18.1525-18	18.1525-20
□		6 mm	18.1526-15	18.1526-18	18.1526-20

Laminektomie spreizer
Laminectomy spreaders
Ecarteurs pour laminectomie
Separadores para laminectomia

18

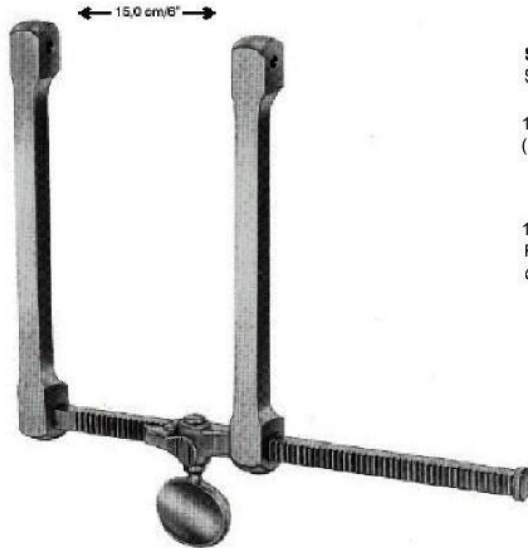

Scoville
Set, set, série, juego

18.1540-00
(1 x 18.1540-01, 1 x 18.1543-50, 1 x 18.1545-01)

18.1540-01
Rahmen allein, frame only,
cadre seul, cuadro solo

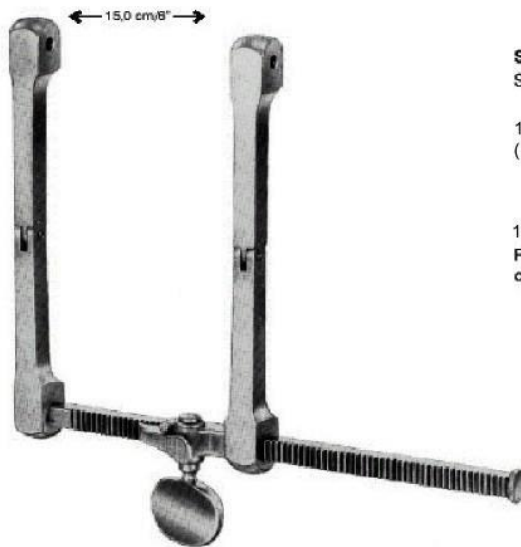

Scoville-Haverfield
Set, set, série, juego

18.1541-00
(1 x 18.1541-01, 1 x 18.1543-50, 1 x 18.1545-01)

18.1541-01
Rahmen allein, frame only,
cadre seul, cuadro solo

Separadores para laminectomia
Separadores para laminectomia

Laminectomie spreizer
Laminectomy spreaders
Ecarteurs pour laminectomie
Separadores para laminectomia

Haken, Hooks, Crochets, Separadores



Scoville
stumpf, blunt
mousse, roma

- 18.1543-50 50 mm/2"
- 18.1343-70 70 mm/2¾"
- 18.1343-75 75 mm/3"



Scoville
spitz, sharp
pointu, agudo

- 18.1544-50 50 mm/2"
- 18.1544-70 70 mm/2¾"
- 18.1544-75 75 mm/3"

18

Valven, Blades, Valves, Valvas



Scoville

- 18.1545-01 64 x 25mm
- 18.1545-02 64 x 29mm
- 18.1545-03 64 x 50mm
- 18.1545-04 88 x 25mm



Taylor

- 18.1546-01 64 x 25mm



Taylor

- 18.1547-01 64 x 25mm
- 18.1547-02 64 x 29mm
- 18.1547-03 64 x 50mm
- 18.1547-04 88 x 25mm



Scoville

- 18.1548-01 64 x 25mm
- 18.1548-02 64 x 29mm



Taylor

- 18.1549-01 32 x 75 mm
- 18.1549-02 42 x 100 mm



Meyerdig-Scoville

- 18.1550-01 50 x 25 mm
- 18.1550-02 70 x 25 mm
- 18.1550-03 83 x 25 mm

gezahnt
saw edge
dentelée
dentada

Laminektomie spreizer
 Laminectomy spreaders
 Ecarteurs pour laminectomie
 Separadores para laminectomia

18



Cloward

18.1560-01 25,0 cm/9½"
 Sperrer allein, spreader only
 ecarteur seule, separador solo

18.1560-00
 Set mit 5 gezahnten Valven 18.1561-40 - 18.1561-60
 Set with 5 toothed blades 18.1561-40 - 18.1561-60
 Jeu avec 5 valves dentelées 18.1561-40 - 18.1561-60
 Juego con 5 valvas dentadas 18.1561-40 - 18.1561-60



Valve, gezahnt
 Blade, saw edge
 Valve, dentelée
 Valva, dentada

18.1561-40 40 mm
 18.1561-45 45 mm
 18.1561-50 50 mm
 18.1561-55 55 mm
 18.1561-60 60 mm



Cloward

18.1562-01 17,0 cm/6¾"
 Sperrer allein, spreader only
 ecarteur seule, separador solo

18.1562-00
 Set mit 5 stumpfen Valven 18.1562-40 - 18.1562-60
 Set with 5 blunt blades HB 18.1562-40 - 18.1562-60
 Jeu avec 5 valves mousses 18.1562-40 - 18.1562-60
 Juego con 5 valvas romas 18.1562-40 - 18.1562-60



Valve, stumpf
 Blade, blunt
 Valve, mousse
 Valva, roma

18.1562-40 40 mm
 18.1562-45 45 mm
 18.1562-50 50 mm
 18.1562-55 55 mm
 18.1562-60 60 mm